



ITT

McDonnell & Miller Installation & Maintenance Instructions MM-705(B)

No. 11, 11M and 11MV

Replacement Switch

For use on Series 61, 64, 764, 67,
767, 69 and 70 Low Water Cut-Offs

- 11** General Purpose (BLACK terminal panel)
- 11M** Manual Reset Option (BLACK terminal panel)
- 11MV** Millivolt / 24V Option (RED terminal panel)

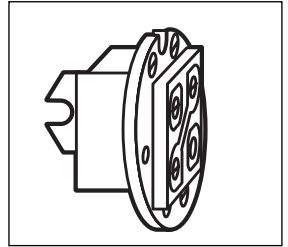

Electrical Ratings

Voltage	Motor Switch Rating (Amperes)		Pilot Duty
	Full Load	Locked Rotor	
120 VAC	7.2	43.2	120 VA at
240 VAC	3.6	21.6	120 or 240 VAC

NOTE: 11MV is rated at 24VA @ 24 VAC to 120 VAC



WARNING

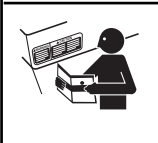

- Before using this product read and understand instructions.
- Save these instructions for future reference.
- All work must be performed by qualified personnel trained in the proper application, installation, and maintenance of plumbing, steam, and electrical equipment and/or systems in accordance with all applicable codes and ordinances.



- To prevent electrical shock, turn off the electrical power before making electrical connections.
- The low water cut-off switch must be installed in series with all other limit and operating controls installed on the boiler. After installation, check for proper operation of all of the limit and operating controls, before leaving the site.

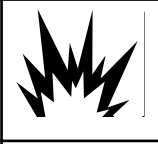

- We recommend that secondary (redundant) Low Water Cut-Off controls be installed on all steam boilers with heat input greater than 400,000 BTU/hour or operating above 15 psi steam pressure. At least two controls should be connected in series with the burner control circuit to provide safety redundancy protection should the boiler experience a low-water condition. Moreover, at each annual outage, the low water cutoffs should be dismantled, inspected, cleaned, and checked for proper calibration and performance.



- To prevent serious personal injury from steam and hot water make sure there is a discharge line from the blow down valve to a proper place of disposal.



- To prevent a fire, do not use this low water cut-off to switch currents over 7.2A, 1/3 HP at 120 VAC or 3.6A, 1/3 HP at 240 VAC, unless a starter or relay is used in conjunction with it.

Failure to follow this warning could cause property damage, personal injury or death.

OPERATION - 11 AND 11MV

The No. 11 switch contains two (2) single pole single throw switches to control a water feeder and the low water cut-off. The low water cut-off switch is between terminals marked "1" and "2". The switch at terminals "3" and "4" can be used to control a McDonnell & Miller electric water feeder or a low water alarm. The No. 11MV has the same switch arrangement as the No. 11. This switch has special contacts for the low water cut-off terminals "1" and "2" for use on millivolt-potential gas valve control systems or 24VAC burners. Some millivolt systems have terminals on the gas valve marked "L1" and "L2" which can be utilized for wiring a limit switch. Others have both thermostat and pressure control in series; if so, simply wire this pair of terminals in series with them. A second switch (at "3" and "4") can be used on 24 volt circuits only for an alarm or electric feeder control.

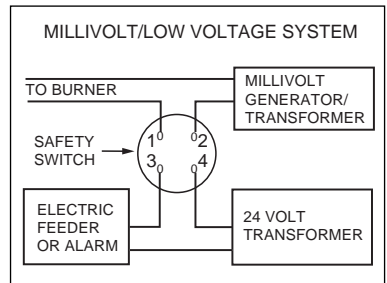
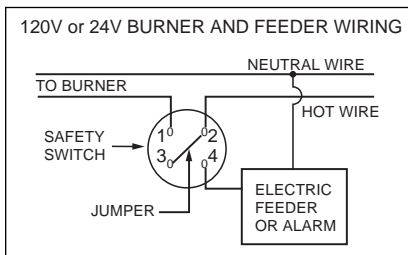
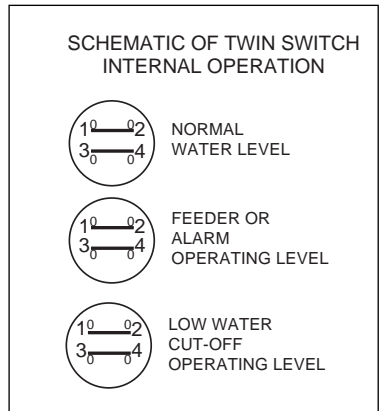

OPERATION - 11M

The No. 11M is a SPDT switch with a latching mechanism. Terminal "2" is the common. At normal water level, a circuit through terminal "1" is closed. It latches open in a low water condition.

Depressing the manual reset button unlatches the mechanism after normal water level has been restored to the control. Terminal "4" provides a contact only for an alarm at low water and is NOT intended for use with an electric feeder.

⚠ CAUTION

Do not electrically connect water feeder to a No. 11M. This model includes a manual reset feature, failure to follow this caution could result in boiler flooding and property damage.

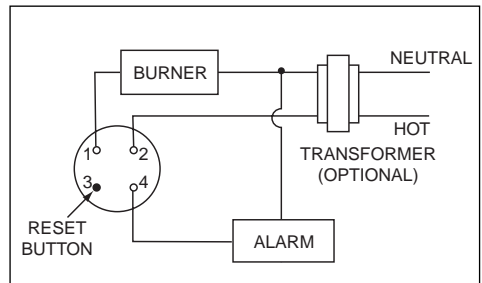
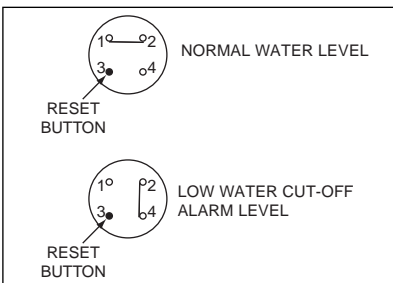

INSTALLATION/REPLACEMENT PROCEDURE

Turn off boiler power. Allow boiler to cool to room temperature. Using a flatblade screwdriver, remove the terminal cover (B). Tag and remove wiring from terminals. Remove screws (D) and housing (C). Remove four (4) switch mounting screws (E) and old switch (F). Install new switch, "TOP" notch up and being certain to align "U-shaped"

notch of switch rocker on float mechanism roller (J). Secure switch on bracket (H) with screws (E). Reassemble housing (C) with screws (D). Reconnect wiring as tagged to proper terminals and reassemble terminal cover (B) with screw (A). Restore power to boiler and test through several cycles.

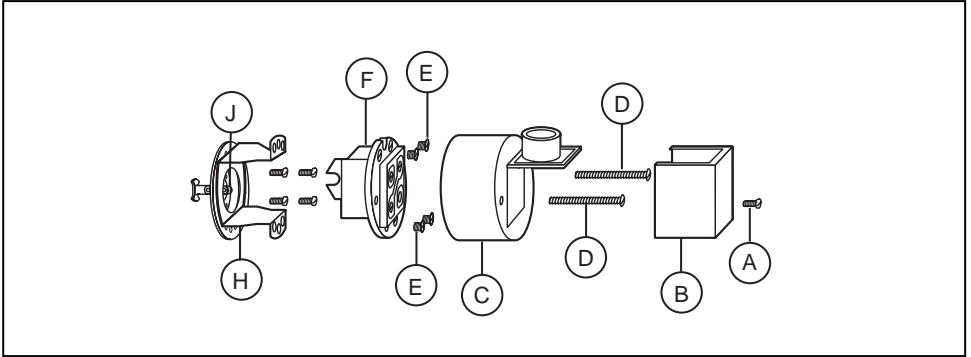

Conduit housing is movable into any one of four positions. Remove two screws (D) and rotate to desired position. NOTE: 11M cannot be rotated out of "TOP" position due to reset button orientation requirement.

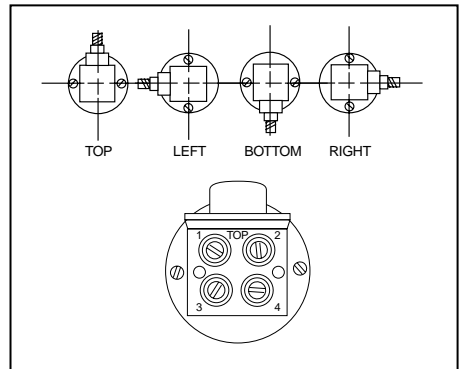



ITT

McDonnell & Miller

MAINTENANCE SCHEDULE:

- Blow down weekly during heating season.
- Check all wiring for brittle or worn insulation.
Replace control every 10 years.

Follow ASME Boiler and Pressure Vessel Code - Section VI Paragraph 7.07G. It states that the controls should be dismantled annually by qualified personnel, to the extent necessary to insure freedom from obstructions and proper functioning of the working parts.

TROUBLESHOOTING

Problem:

1. **Control does not turn burner off on low water.**
2. **Control does not turn electric feeder off.**

Cause: Contacts may be fused from overload.

Test: With a continuity meter or ohm meter check if both circuits open as the rocker is moved through its operating range.

Solution: Replace the switch if either circuit remains closed through the test. Refer to the installation / replacement procedure.

If the switch functions normally off of the control, inspect the float and interior chamber condition for obstructions and debris, especially around the bellows area and at the gauge glass end.